

ALL DIMENSIONS ARE APPROXIMATE

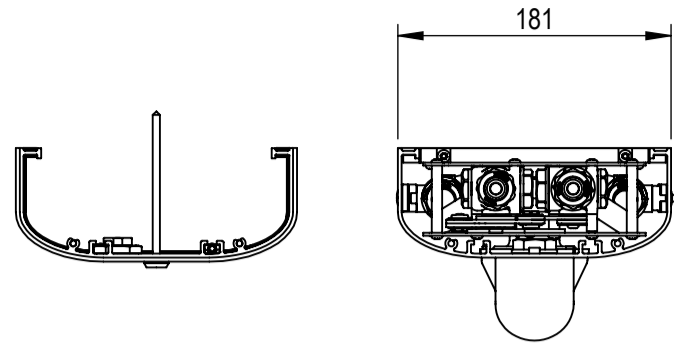

TOTAL HEIGHT OF PANEL + PIPECOVER  
 = 1006 + 2 + 455 + 50 - (OVERLAP)

- OVERLAP IS VARIABLE BETWEEN 20-40MM
- 455 LENGTH CAN BE CUT TO SUIT

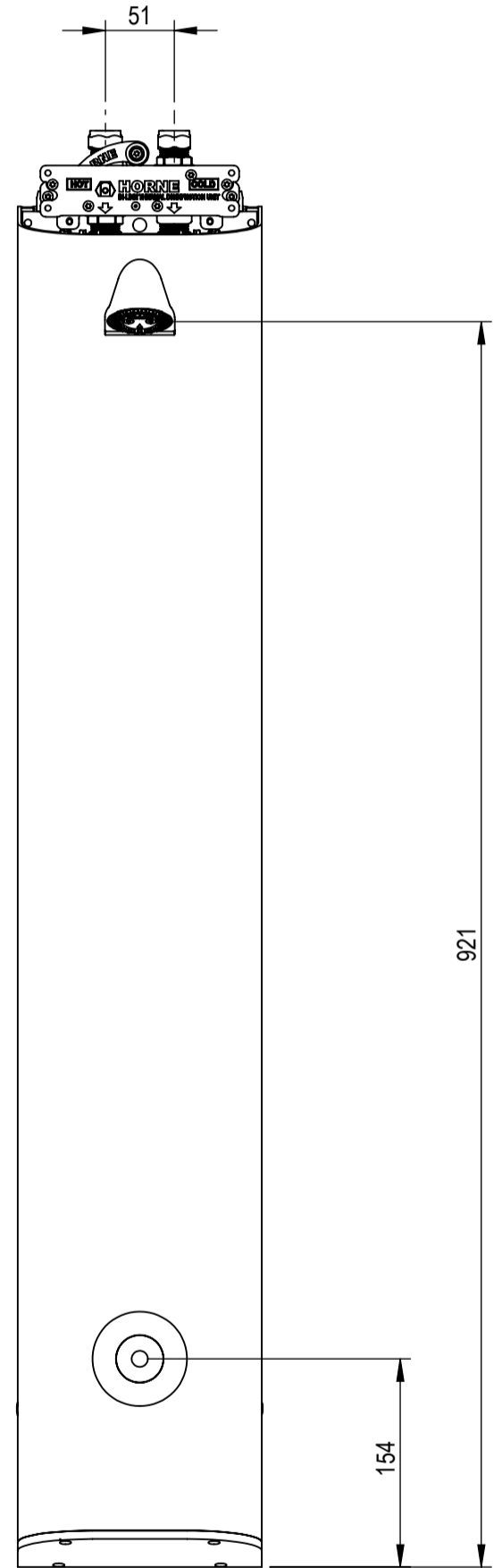
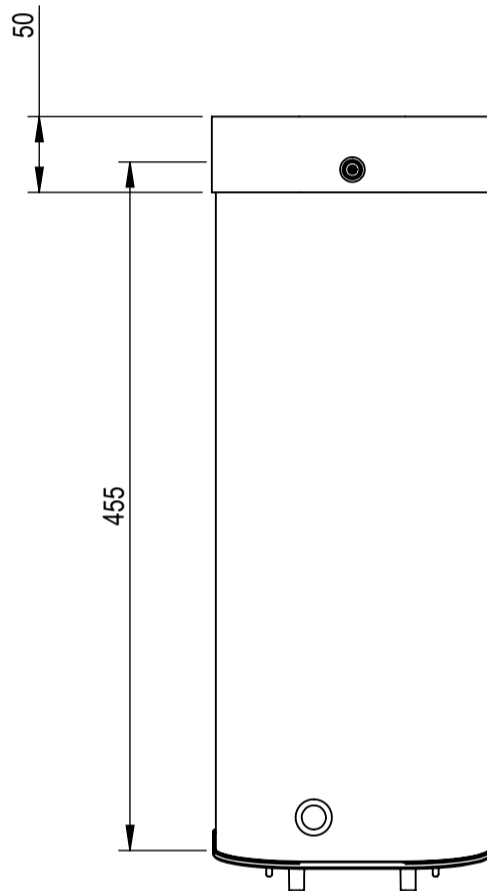
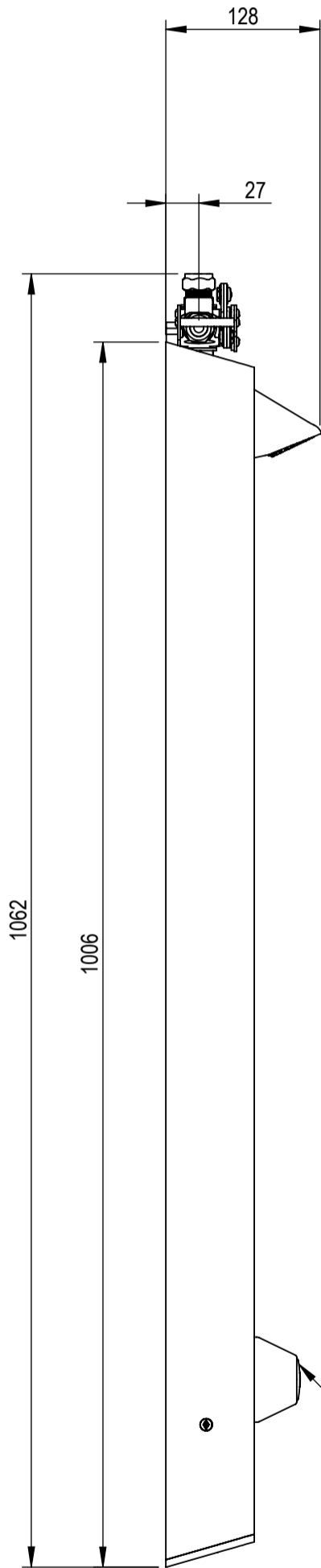

COPYRIGHT 2014, HORNE ENGINEERING LTD. ALL REPRODUCTION PROHIBITED UNLESS AUTHORISED IN WRITING.  
 THIS DRAWING CONTAINS CONFIDENTIAL AND PROPRIETARY INFORMATION OF HORNE ENGINEERING LIMITED AND UNAUTHORISED DISCLOSURE IS STRICTLY PROHIBITED.

DRN BY	MJ (22/01/2016)	MODEL REV.	A-01
CHK'D BY		DRG REV.	B-01

HORNE ENGINEERING LTD. JOHNSTONE RENFREWSHIRE PA5 8BD			CONFIG OF: 6270
SHEET 1 OF 1	DO NOT SCALE	A3	
PRODUCT: T109T4-LR			DRG No. 11372