

ALL DIMENSIONS ARE APPROXIMATE

TOTAL HEIGHT OF PANEL + PIPECOVER
 = 1006 + 2 + 455 + 50 - (OVERLAP)

- OVERLAP IS VARIABLE BETWEEN 20-40MM
- 455 LENGTH CAN BE CUT TO SUIT

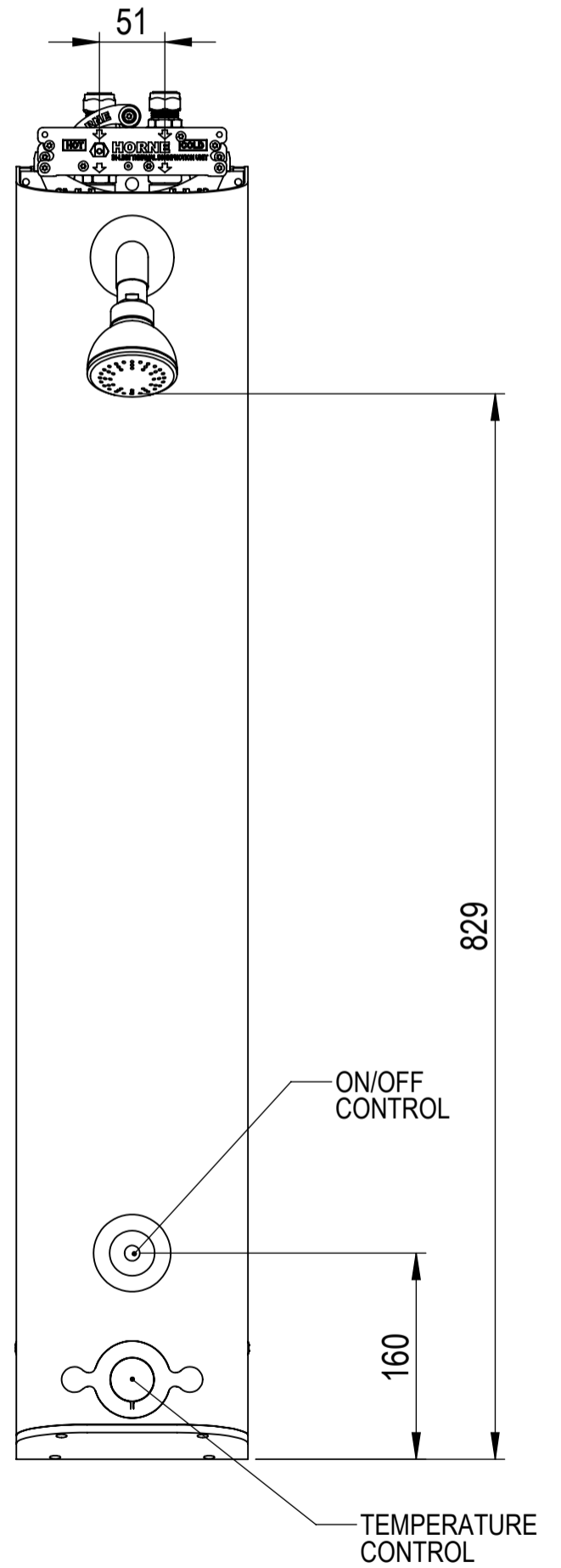
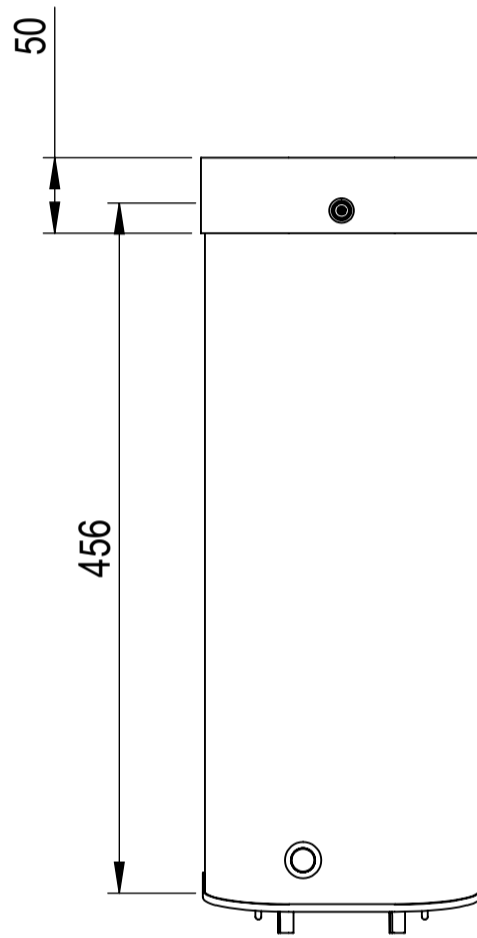
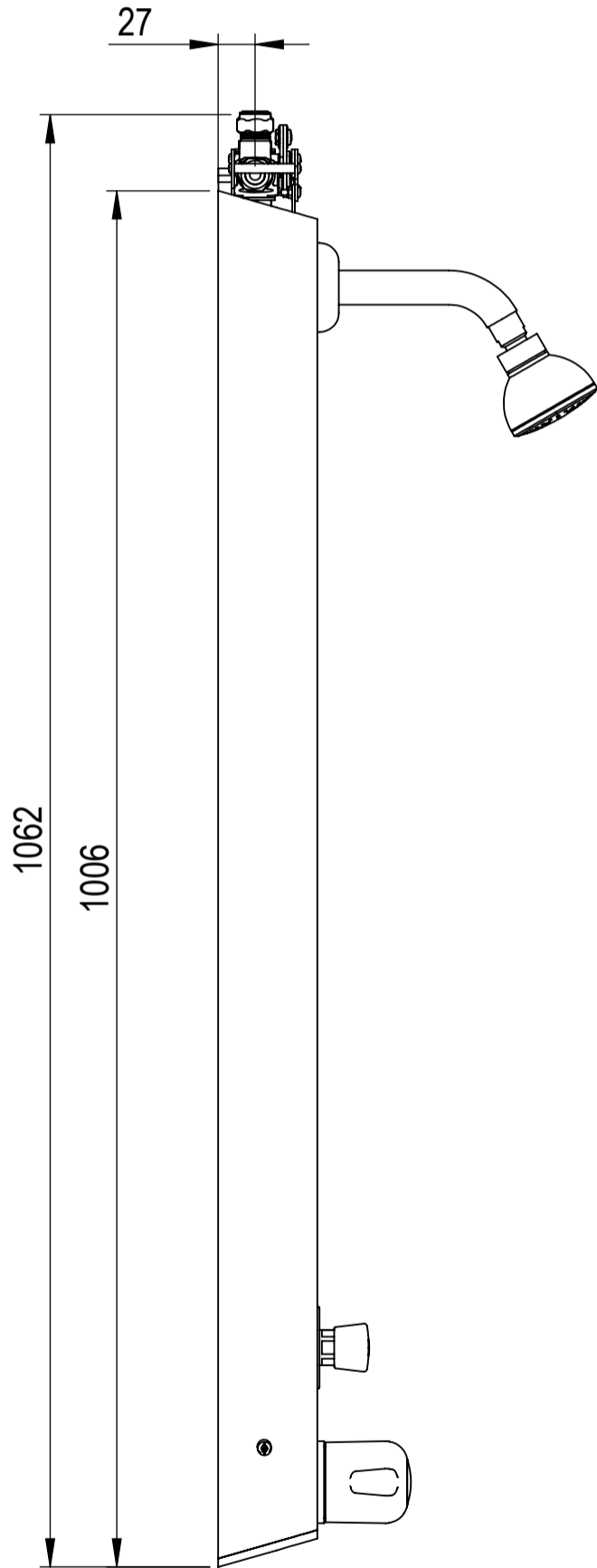
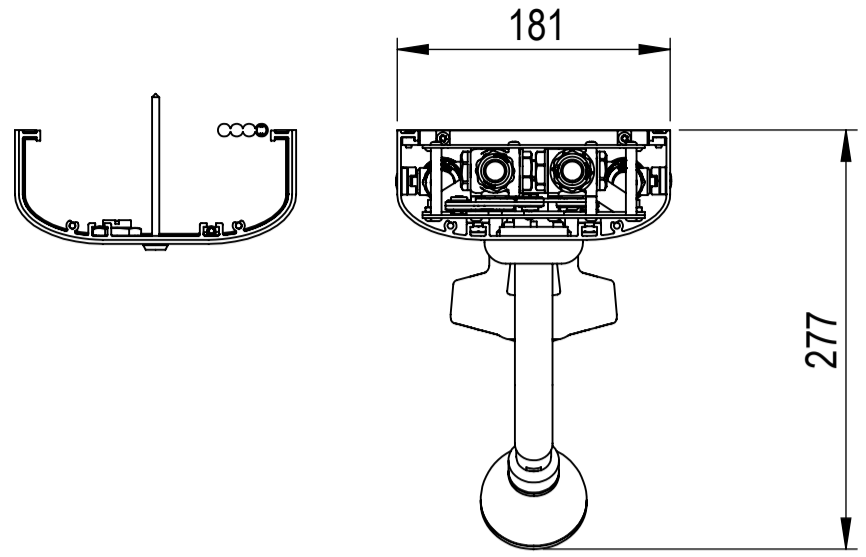

COPYRIGHT 2016, HORNE ENGINEERING LTD. ALL REPRODUCTION PROHIBITED UNLESS AUTHORISED IN WRITING. THIS DRAWING CONTAINS CONFIDENTIAL AND PROPRIETARY INFORMATION OF HORNE ENGINEERING LIMITED AND UNAUTHORISED DISCLOSURE IS STRICTLY PROHIBITED.

DRN BY CE (14/10/22)
 CHK'D BY

MODEL REV. A-06.
 DRG REV. B-02.

HORNE ENGINEERING LTD.
 JOHNSTONE
 RENFREWSHIRE
 PA5 8BD

SHEET 1 OF 1

DO NOT SCALE

CONFIG OF: 6250

A3

PRODUCT: T206T41L

DRG No. 11366